

Evolv DNA 75

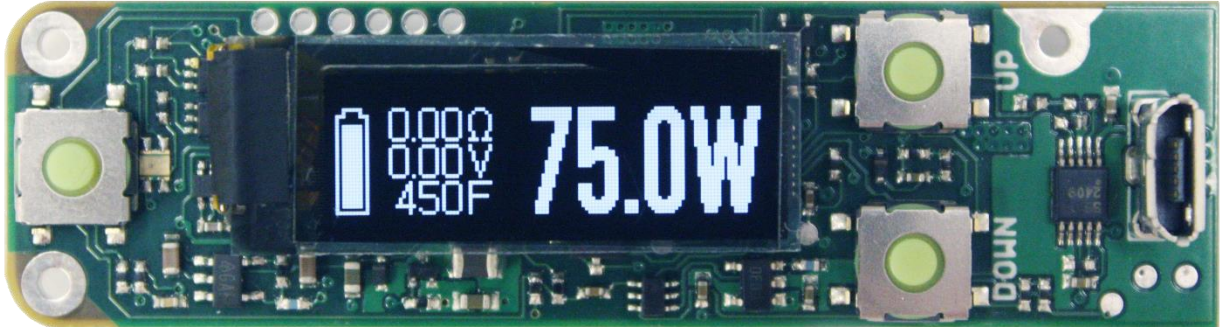

75 Watt Variable Power Module with Temperature Protection and USB

The DNA 75 is a power regulated digital switch-mode DC-DC converter for personal vaporizers. It features Evolv's patented Wattage Control, Temperature Protection, Preheat, OLED Screen, Reverse Polarity Protection, onboard programmable multicolor LED and waterproof onboard buttons. The USB port and Evolv's EWrite software can be used to customize or monitor the user experience. The DNA 75 runs from a single lithium polymer or lithium ion battery, and features battery monitoring and integrated 1A charger.

Specifications

	Minimum	Typical	Max
Output Power	1 Watt		75 Watts
Output Voltage	.2 Volt		6.2 Volts
Output Current, continuous			30.0 Amps
Output Current, instantaneous peak			40.0 Amps
Atomizer Resistance, temperature sensing wire, cold	See Graph	.15 Ohm	See Graph
Atomizer Resistance, Kanthal wire	See Graph	.25 Ohm	See Graph
Temperature Limit	200°F	450°F	600°F
Input Voltage	3.0 Volts	3.7 Volts	4.2 Volts
Input Current	.5 Amps	12.0 Amps	28.0 Amps
Input Current, pulse			32.0 Amps
Screen On Current		26mA	
Quiescent Current		7mA	
Power Down Current		0mA	
Efficiency		85%	
Weight		15g	
Footprint	.71" x 2.60"		18mm x 66mm
Thickness		.32"	
Screen size		.91" OLED	

Contents

- Specifications 1
- Temperature Protection 3
 - Preheat..... 3
 - Attaching a New Atomizer 4
- Output Power..... 4
- Operation 5
 - Display..... 5
 - Alternate display items 5
 - Modes 6
 - Profiles 7
 - Error Messages 8
 - Auto power down 8
- Charger..... 9
 - Battery monitoring..... 9
- Escribe..... 9
- Pinout (shown bottom side) 10
- Wiring..... 11
 - Recommended wire sizes 11
 - Reverse Polarity Protection 11
 - External component recommendations 11
- Assembly 12
 - Installing the Screen..... 12
- Mounting..... 13
- Mechanical Dimensions 14

Temperature Protection

The DNA 75 directly measures and limits the temperature of the heating coil during operation. By preventing the coil from becoming too hot regardless of fluid, wicking or airflow, a variety of undesirable situations can be prevented. For example, appropriate temperature settings will prevent the wicking material from charring, which compromises taste and introduces unintended chemicals into the vapor. Appropriate temperature settings will also reduce the breakdown of flavoring and base liquid components, which could impact taste or safety.

Evolv's Temperature Protection Technology requires a heating coil made from Nickel 200 alloy or other materials with a well-defined temperature coefficient of resistance, rather than Nickel Chromium or Kanthal alloys. If the temperature reaches the maximum value, the wattage applied to the atomizer coil is reduced to prevent overheating. Please note that the temperature reading is the average temperature of the atomizer coil, and care should be taken to construct the heating coil so that the temperature is uniform, without hot or cold spots.

Because wattage, not temperature controls vapor volume, large vapor volumes can be produced without unnecessarily high temperatures. Temperature Protection is most helpful if the atomizer begins to dry out, the user pauses during a puff, the beginning or end of the puff, or if the wattage setting is inappropriate for the attached atomizer.

In normal operation, when the device is not firing the maximum temperature setting is displayed on the screen. When the device is firing, the actual average temperature of the coil is displayed on the screen.

By default, the Temperature Protection setting is 450° Fahrenheit. To change the limit

- 1) Lock the device by pressing the Fire button five times.
- 2) Hold down the UP and DOWN adjust buttons for two seconds.
- 3) After two seconds, the maximum temperature will be displayed, and the UP and DOWN buttons should be released.
- 4) Use the UP and DOWN buttons to adjust the maximum temperature
- 5) When the display shows the desired maximum temperature, press the Fire button to exit temperature adjust mode.

The maximum temperature is adjustable between 200° Fahrenheit and 600° Fahrenheit. To disable the temperature protection entirely, adjust the limit up to 600 degrees, then press the UP button one additional time. The temperature limit will read OFF.

To switch to Celsius temperature, adjust temperature down to 200° Fahrenheit, then press the DOWN button one additional time. The temperature will switch to reading and adjusting in Celsius.

Preheat

When the DNA 75 is used with a temperature sensing atomizer, an additional feature called Preheat is activated. No vapor is produced when the temperature is below the boiling point of the liquid. Preheat applies extra power until the heating coil is up to operating temperature to shorten the

delay between pressing the fire button and generating vapor. Because preheat is temperature based, it will not overheat or burn the vapor.

Attaching a New Atomizer

The DNA 75 uses the resistance of the atomizer to calculate the temperature of the heating coil. It continually looks to see whether a new or changed atomizer has been connected. If you are using temperature protection, be careful to only attach new atomizers that have cooled to room temperature. If a new atomizer is attached to the DNA 75 before it has cooled down, the temperature may read and protect incorrectly until the new atomizer cools.

When you connect a new atomizer or disconnect and reconnect your existing atomizer, the DNA 75 will prompt you to confirm this change. When you fire the first time, before activating the DNA 75 will prompt "New Coil? UP YES/DOWN NO". When you see this prompt, if you have attached a new atomizer, press the UP button. If you have disconnected and reconnected the same atomizer, press the DOWN button.

Output Power

The following graphs show the output power range of the DNA 75 as a function of the coil resistance.

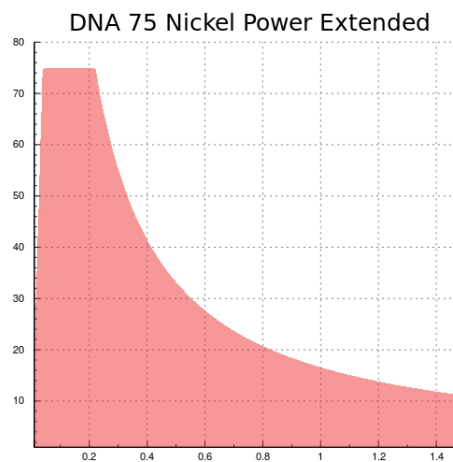
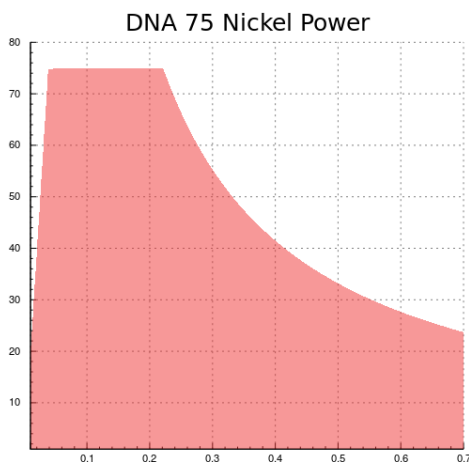
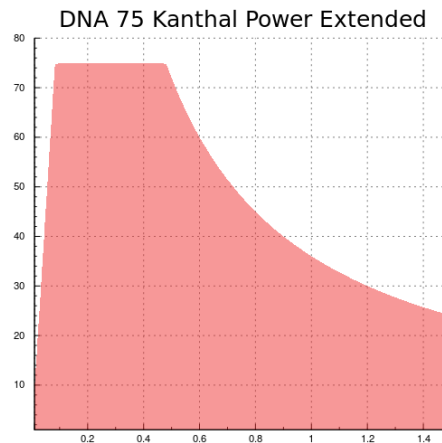
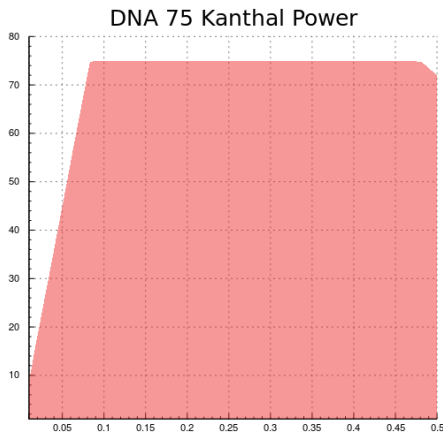

Operation

Basic operation of the DNA 75 is as follows. To wake the device from power off state, tap the Fire button. To generate vapor, press the Fire button. To change the wattage setting for more or less vapor, click or hold the Up and Down buttons.

Display

The DNA 75 has a small .91" diagonal white OLED screen. The screen is attached to the main board by a flexible cable, allowing freedom in the design of your device. The screen's default position is on top of the board, between the fire and adjust buttons. This allows for easy assembly. The screen connects to the board with a ZIF connector, so alternate placement is possible. It is also possible to order screens with custom length and shape flexible cables, allowing screen placement anywhere in the device. Please use caution when handling the screen and design the device so that the cable will be secured or strain relieved in operation.

Watt setting: The power level currently set on the DNA 75.

Battery indicator: The current state of charge of the battery.

Temperature display: When not firing, the maximum heating coil temperature setting. While firing, the actual temperature of the heating coil is displayed.

Volts display: The output voltage being supplied to the atomizer.

Ohms display: The resistance of the atomizer attached to the device. When using a temperature sensing coil, this is the normalized resistance of the coil at 70°F

Alternate display items

Any of the following items can be displayed during operation or charging in lieu of the standard Ohms, Profile Name or Temperature displays. The Escribe PC software is used to change the display settings. A detailed description of each item can be found in the Escribe manual

Battery Charge	Output Current	Average Output Power of the most recent puff
Battery Pack Voltage	Output Voltage	Average Temperature of the most recent puff
Room Temperature	Material Name	Total Energy of the most recent puff
Puff Count	Board Temperature	Duration of the most recent puff

Modes

Locked mode: Pressing the fire button five times with less than .7 seconds between presses will cause the device to enter Locked mode. In Locked mode, the device will not fire and the output power will not adjust accidentally. While in Locked mode, the screen will be off, except that pressing a button will show “Locked, Click 5X”. To exit Locked mode, press the fire button 5 times.

Stealth mode: While locked, holding the fire and down buttons simultaneously for five seconds will switch to stealth mode. In this mode the display is off. It will still show error and lock messages. To switch back to normal display mode, hold down the fire and down buttons simultaneously for 5 seconds. This setting is stored to internal flash memory, and remains if power is removed.

Power Locked mode: Holding down both the up and down buttons for two seconds will place the device in Power Locked mode. In this mode, the mod will operate normally, but you will not be able to change the power setting. This mode prevents accidental power level changes due to the buttons being pressed while in a pocket. To exit Power Locked mode, hold the up and down buttons for two seconds.

Resistance lock: The DNA 75 relies on the cold resistance of the atomizer to measure temperature accurately. If the connection is not stable or if you find the measured resistance drifts with time, it may be desirable to lock the atomizer resistance. To do so, while locked hold both the Fire and Up buttons for two seconds to enter Resistance Lock mode. In this mode, the DNA 75 will use the present atomizer cold resistance without refinement until the atomizer is disconnected or the resistance lock is disabled. A lock symbol will replace the ohm symbol on the display. To disable resistance lock, repeat the procedure to lock it.

Max Temperature Adjust: From Locked Mode, holding down both the up and down buttons for two seconds will place the device in Max Temperature Adjust mode. Once this mode is entered, the max temperature will be displayed. The up and down buttons are used to adjust the max temperature. To save the new temperature setting and exit, press the Fire button.

Profiles

The DNA 75 allows you to save and select between eight groups of output settings. Each group of output settings is called a Profile. To switch between profiles, put the DNA 75 into Power Locked mode by pressing and holding both the up and down buttons simultaneously for two seconds. From power locked mode, to cycle between profiles, double click the Up or Down button. To select the displayed profile, press the fire button.

The coil material for each Profile can be changed directly on the device for any material that exists in the Materials Repository. To change the currently selected Profile's material, press the Fire button five times to Lock the device. With the device Locked, hold the Up, Down, and Fire buttons simultaneously for two seconds. Then, use the Up and Down buttons to cycle through materials, when the desired material is displayed press the Fire button to confirm your selection.

Each profile contains an output power setting and a maximum temperature setting. These can be adjusted on the device, and will be saved when a different profile is selected. Additionally, the resistance lock setting and value for each atomizer is saved in the profile, which can alleviate temperature inaccuracies stemming from attaching atomizers before they have completely cooled. Many more output settings, including the coil material and preheat settings can be adjusted on a per-profile basis using the Escribe PC software.

Evolv recommends setting up one profile for each atomizer that you regularly use with the DNA 75. It is much faster to switch profiles than it is to set up the settings for the atomizer again.

Error Messages

The DNA 75 will indicate a variety of error states.

Check Atomizer: The DNA does not detect an atomizer, the atomizer has shorted out, or the atomizer resistance is incorrect for the power setting.

Shorted: The atomizer or wiring are short circuited.

Weak Battery: The battery needs to be charged, or a higher rate battery needs to be used. If this happens, the DNA 75 will continue to fire the atomizer, but will not be able to provide the desired wattage. The Weak Battery message will continue to flash for a few seconds after the end of puff.

Check Battery: The battery is deeply discharged and needs to be charged, or is damaged. If this happens, the DNA 75 will not fire the atomizer. The Check Battery message will continue to flash for a few seconds after attempting to fire the device. User should remove and replace the battery.

Temperature Protected: The heating coil reached the maximum allowed temperature during the puff. If this happens, the DNA 75 will continue to fire, but will not be able to provide the desired wattage.

Ohms Too High: The resistance of the atomizer coil is too high for the current wattage setting. If this happens, the DNA 75 will continue to fire, but will not be able to provide the desired wattage. The Ohms Too High message will continue to flash for a few seconds after the end of puff.

Ohms Too Low: The resistance of the atomizer coil is too low for the current wattage setting. If this happens, the DNA 75 will continue to fire, but will not be able to provide the desired wattage. The Ohms Too Low message will continue to flash for a few seconds after the end of puff.

Too Hot: The DNA 75 has onboard temperature sensing. It will shut down and display this message if the internal board temperature becomes excessive.

Auto power down

The screen will be at full brightness while firing. After 10 seconds with no button presses, the screen will dim. 30 seconds after the last button press, the screen will fade out and the device will go into sleep mode. To wake the device, press the fire button.

Charger

The DNA 75 has a built in 1A USB charger. It automatically detects the type of USB power supply it is connected to, so it can be plugged into standard PC USB ports or higher power chargers.

Battery monitoring

The DNA 75 contains a full battery management system that continuously monitors the state and health of the battery both under load and while idle.

Escribe

Escribe is a software package used to configure, monitor and modify the operation of your DNA 75. It installs on a Windows PC and connects to your DNA 75 using the USB port. Escribe has a separate manual and tutorials which can be found on Evolv's site.

Pinout (shown bottom side)

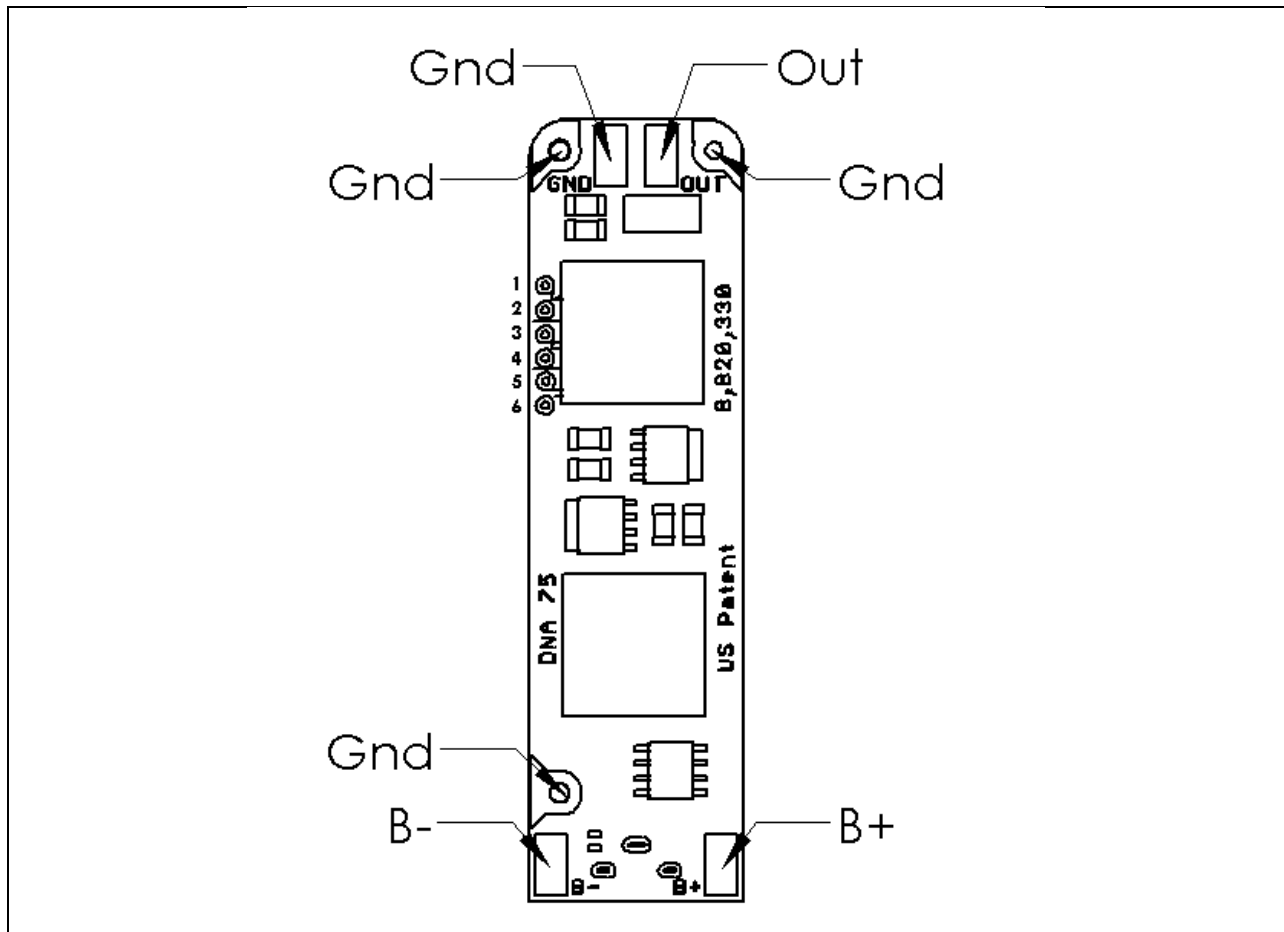

Pin Number	Pin Name	Function
Out	Out	Power output.
1	Fire +	Positive side of the fire button.
2	Fire-	Negative side of the fire button.
3	Up-	Negative side of the power down button.
4	Up+	Positive side of the power down button.
5	Down +	Positive side of the power up button.
6	Down -	Negative side of the power up button.
GND	GND	Power output. GND is the ground return for the atomizer. It is connected internally to B-. There are three ground lugs and one ground pad.
B+	B+	Positive battery terminal.
B-	B-	Negative battery terminal. Internally connected to Gnd

Wiring

The atomizer is connected to the OUT pad. If the DNA 75 is not being grounded through the mounting screws, the GND pad should connect to the negative side of the connector. The battery is connected to the B+ and B- terminals. It is important to use appropriately sized wire when using the DNA. Too small wire will not perform well, and significantly undersized wire can burn out. The output wires should be silicone or Teflon insulated only, and at least 14 gauge. The input wire carries less current, and can be as small as 20 gauge wire if silicone or Teflon insulated.

Recommended wire sizes			
	Minimum size	Recommended size	Maximum size
Battery, silicone insulated	20 gauge	18 gauge	16 gauge
Battery, PVC Insulated	18 gauge	16 gauge	14 gauge
Output, silicone insulated	16 gauge	14 gauge	12 gauge
Switches, if used	28 gauge	24 gauge	22 gauge

Reverse Polarity Protection

The DNA 75 includes built in Reverse Polarity Protection to protect the user, board, device, and battery in the event that a battery is inserted backwards.

External component recommendations

The DNA 75 is a self-contained power regulator which does not require external components for its user interface. However, it does support the use of external interface components if desired.

Fire button:

Use a momentary on, normally open type switch or button. A standard pushbutton switch is appropriate. The switch is a logic function – all power switching is handled with transistors inside the DNA module, so the switch does not need to be rated for power. A waterproof or processed sealed switch is recommended. Please use caution, as the positive side of the fire button connects directly to positive battery voltage.

Up/Down buttons:

The small onboard buttons labeled UP and DOWN allow the user to increase or decrease the power level in .1 Watt increments. Alternatively, remote normally open type switches or buttons can be attached to the UP and DOWN mounting holes for customization.

Battery:

The DNA 75 runs from a single lithium polymer type battery pack or round lithium ion 18650 type battery. The DNA 75 can use multiple cells in a parallel type wiring configuration as long as the maximum input voltage is 4.2v.

Assembly

Installing the Screen

The OLED screen mounts to the DNA 75 using an 8 pin ZIF socket and a flexible cable to allow for design flexibility. The cable can be bent or folded (once) but care should be taken to not apply tension or strain to the area where the cable attaches to the screen itself.

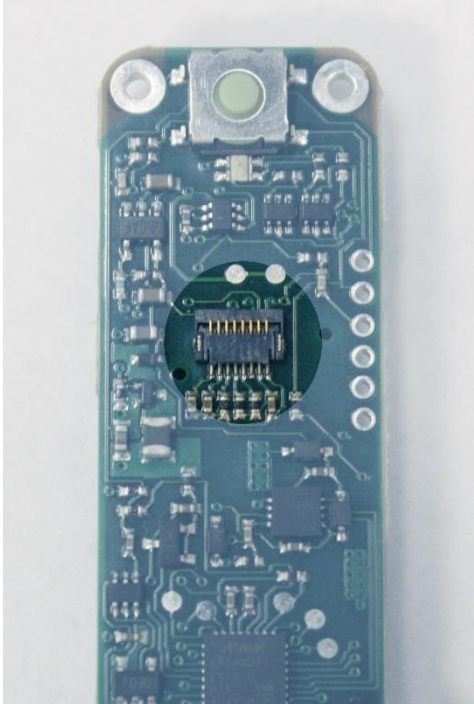
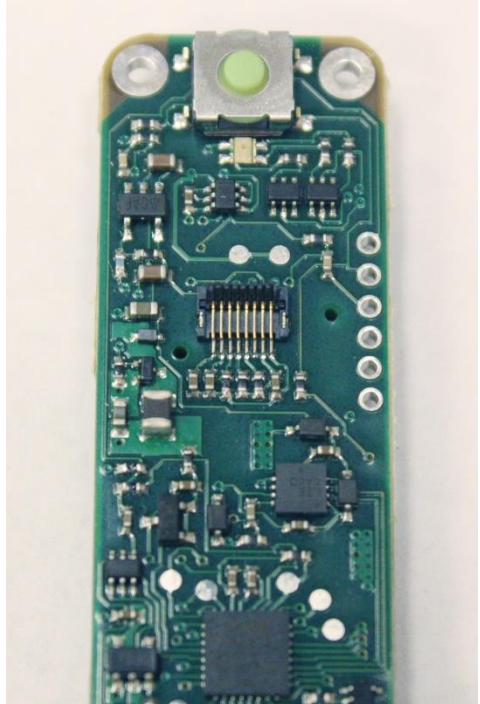
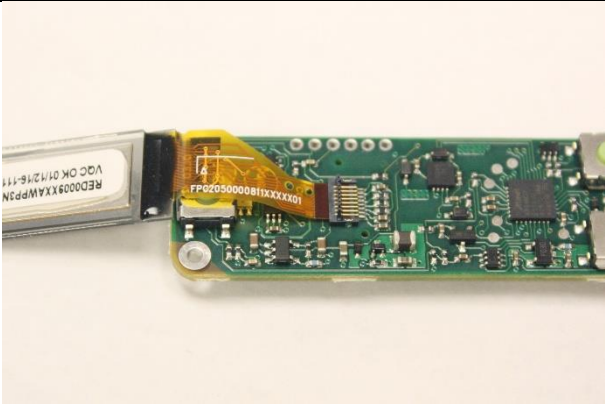
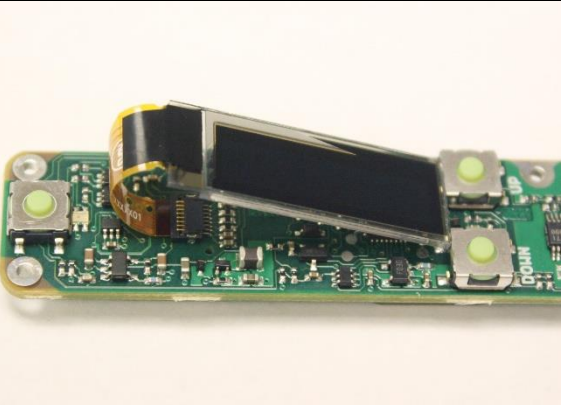
	
<p>Step 1: Locate the ZIF connector on the DNA 75 PCB</p>	<p>Step 2: Carefully and gently lift the locking tab on the rear of the connector to vertical</p>
	
<p>Step 3: Fully insert the flexible cable into the front of the socket with the contact side towards the PCB</p>	<p>Step 4: Close the locking tab and press until the connector gently clicks. Remove the clear screen protector by pulling on the colored tab.</p>

Mounting

The DNA 75 has onboard switches for adjusting the power level and activating the output. Each of these functions also has optional through-hole pads for using remote buttons.

The DNA 75 has three mounting holes on the PCB. These holes are designed for #0 screws. There is an extended mounting pad of .125" diameter around each. These holes are electrically connected to each other and to ground. With careful design, the mounting pads can be used to ground the chassis to the DNA 75, and pass the output current through chassis to the connector. However, if using this method, ensure that the PCB remains in good contact with the board at all times. Split lock washers and a RoHS chromate conversion coating on the chassis are recommended.

Mechanical Dimensions

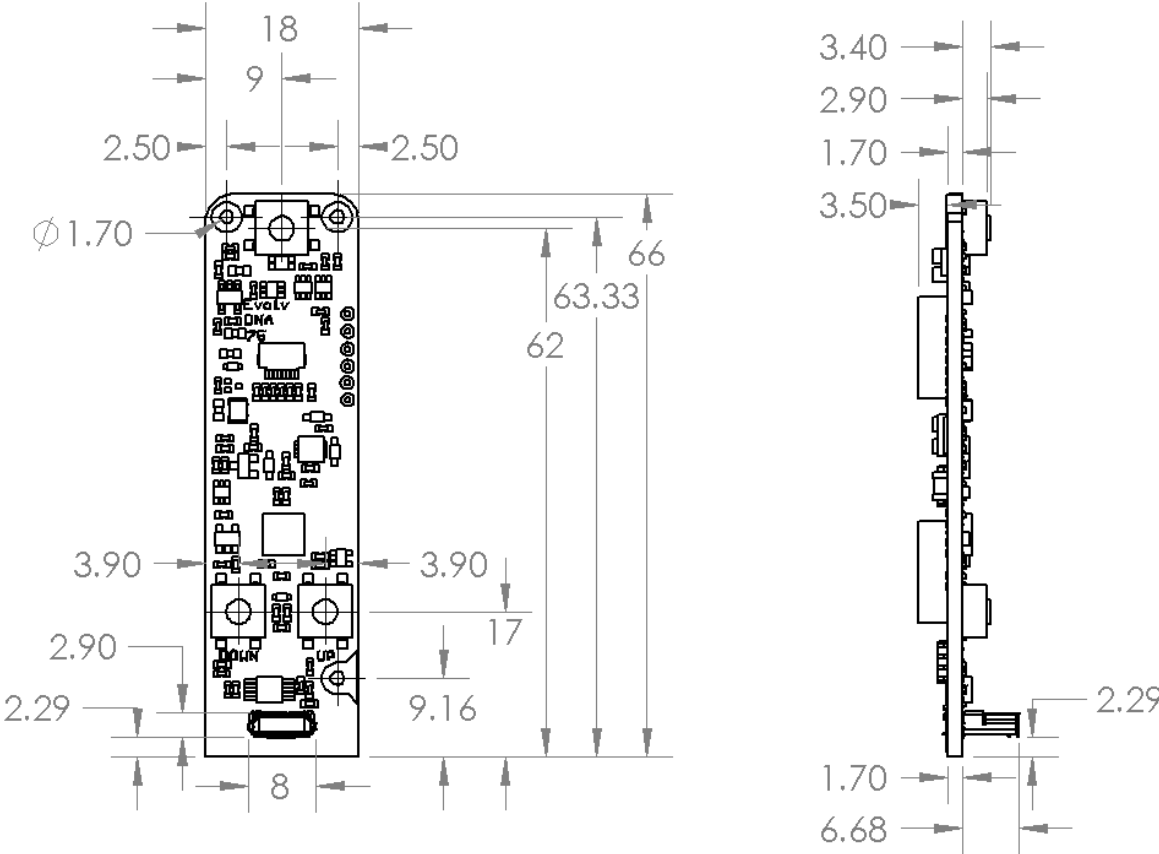

Evolv has 3D models of the DNA 75 available on their website in IGES, STP and Solidworks format.

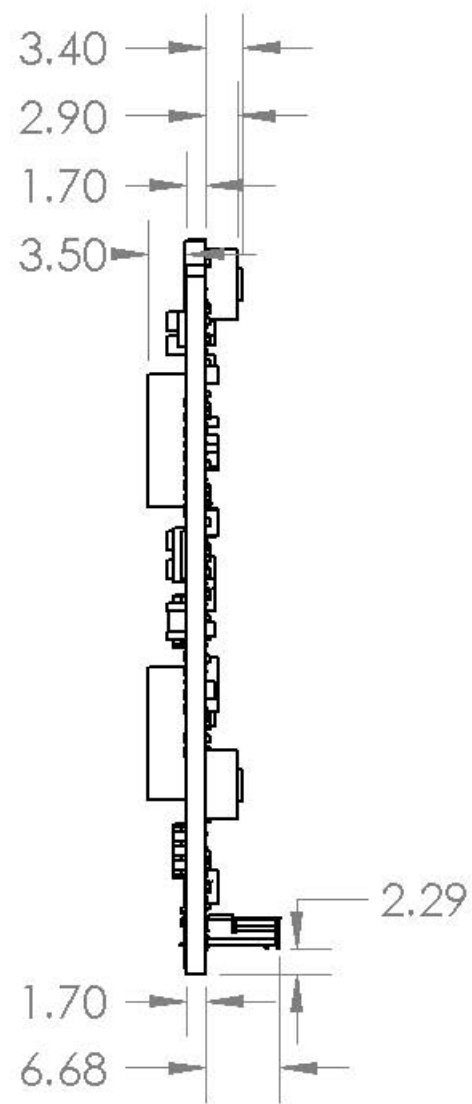
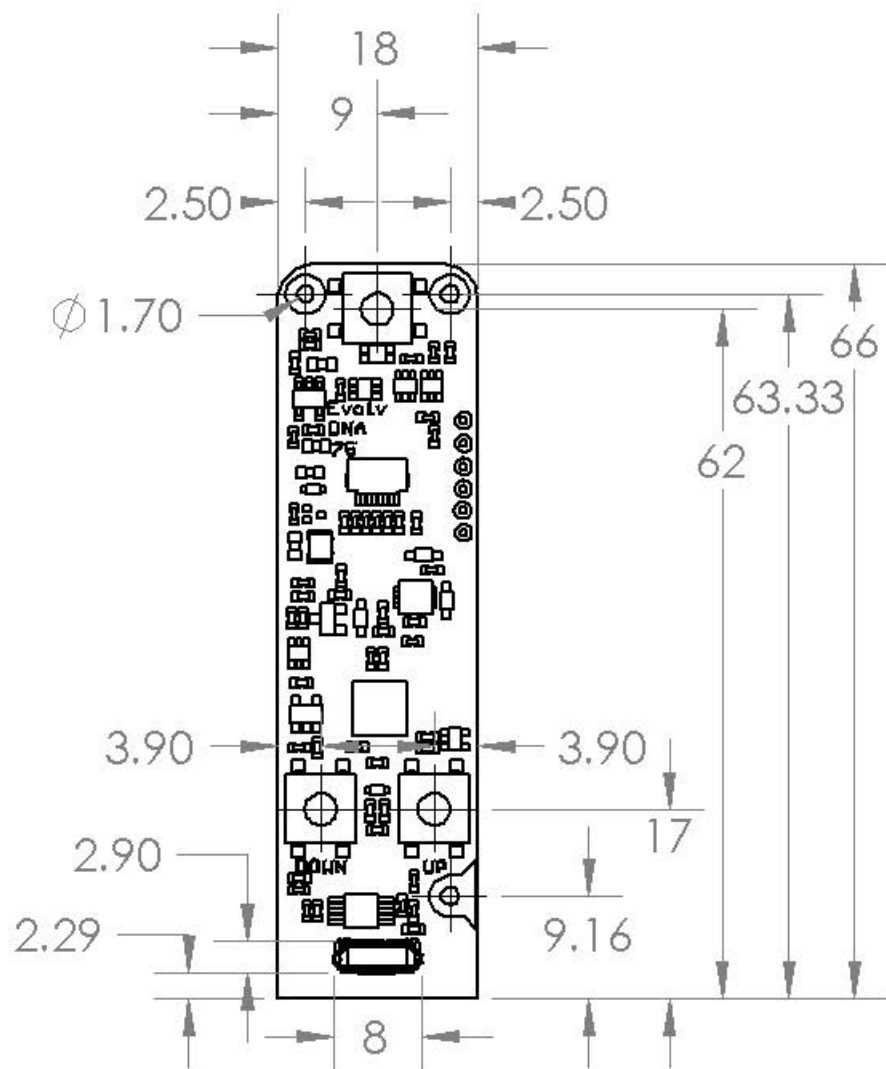

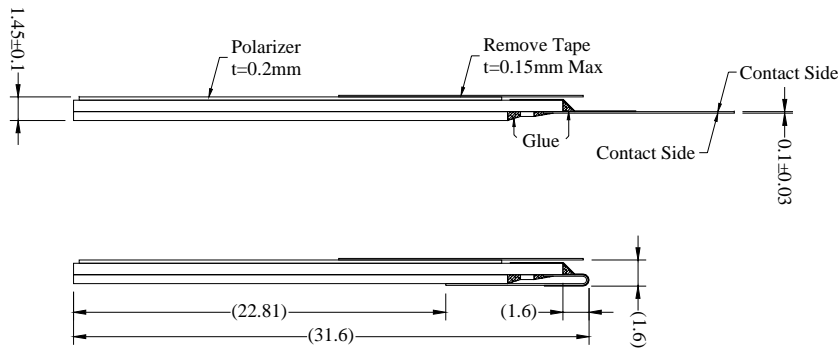
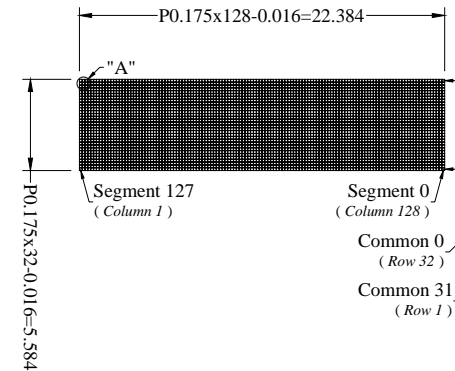
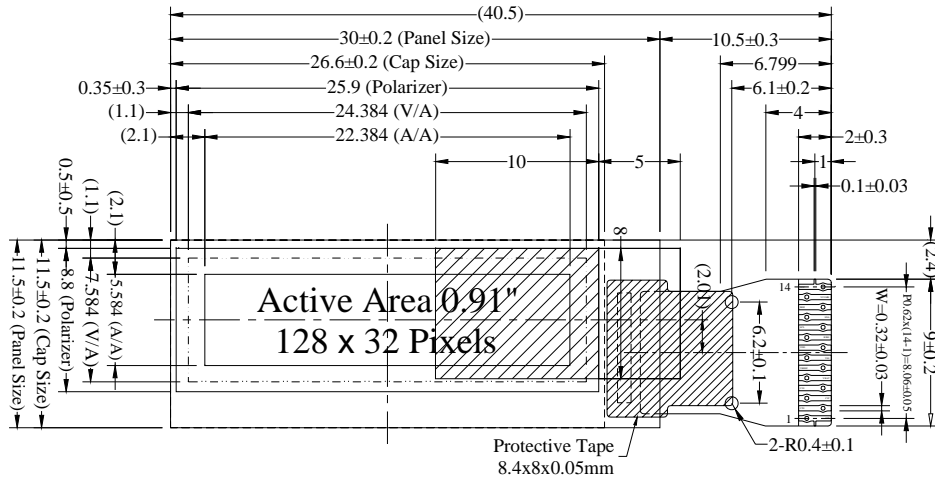

(Reference Mechanical Design)

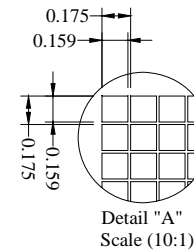

Pin	Symbol
1	C2P
2	C2N
3	C1P
4	C1N
5	VBAT
6	VBREF
7	VSS
8	VDD
9	RES#
10	SCL
11	SDA
12	IREF
13	VCOMH
14	VCC

Notes:

1. Color: White
2. Driver IC: SSD1306
3. Interface: I2C
4. General Tolerance: ±0.30
5. The total thickness (1.55 Max) is without polarizer protective film & remove tape.
The actual assembled total thickness with above materials should be 1.80 Max.

CUSTOMER APVL	CUSTOMER	DATE	
DRAWN	SCALE	TITLE	
DFTG_CHK	UNIT mm	MI12832DO	
ENGR_CHK	APPROVAL	MODEL	
MULTI-INNO TECHNOLOGY CO.,LTD.		DWG NO	PAGE 1/1

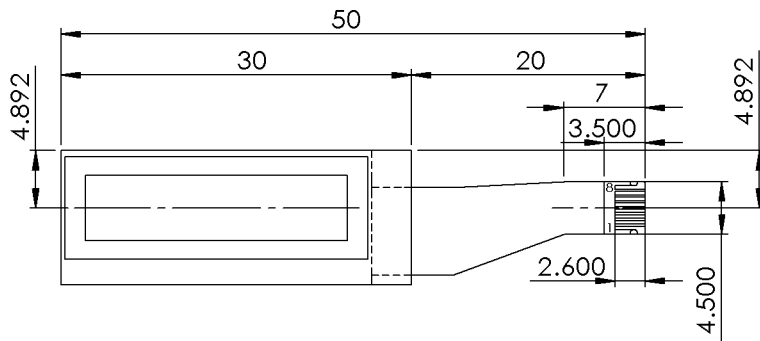

FPC and Stiffener Detail

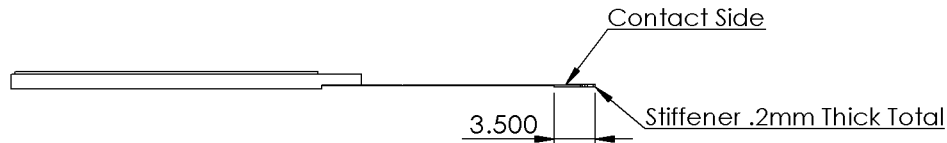
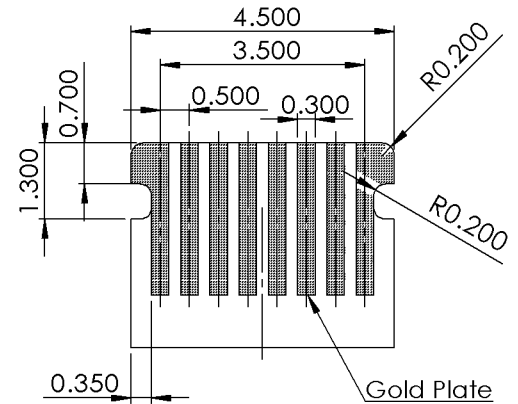

Pin	Symbol
1	VSS
2	VDD
3	RES#
4	SCL
5	SDA
6	IREF
7	VCOMH
8	VCC

Notes:

MI12832DO White
I2C interface

Charge pump not used
C2P, C2N, C1P, C1N,
VBATT, VBREF not connected

For use with connector.
Connector manufacturer: FCI
Connector PN: 59453-08211CHLF

UNLESS OTHERWISE SPECIFIED:		NAME	DATE								
DIMENSIONS ARE IN mm	DRAWN			TITLE:							
	CHECKED										
	ENG APPR.										
	MFG APPR.										
INTERPRET GEOMETRIC TOLERANCING PER:	Q.A.			<table border="1"> <tr> <td>SIZE</td> <td>DWG. NO.</td> <td>REV</td> </tr> <tr> <td>A</td> <td></td> <td></td> </tr> </table>		SIZE	DWG. NO.	REV	A		
SIZE	DWG. NO.	REV									
A											
MATERIAL	COMMENTS:										
FINISH											
DO NOT SCALE DRAWING				SCALE: 2:1	WEIGHT:	SHEET 1 OF 1					